

# TSP60R280S1

## 600V 15A N-Channel SJ-MOSFET

### General Description

Truesemi SJ-FET is new generation of high voltage MOSFET family that is utilizing an advanced charge balance mechanism for outstanding low on-resistance and lower gate charge performance. This advanced technology has been tailored to minimize conduction loss, provide superior switching performance, and withstand extreme dv/dt rate and higher avalanche energy. SJ-FET is suitable for various AC/DC power conversion in switching mode operation for higher efficiency.

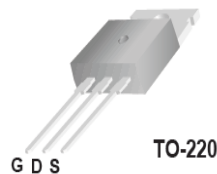

### Features

- 650V @T<sub>J</sub> = 150 °C
- Typ. R<sub>DS(on)</sub> = 0.24Ω
- Ultra Low gate charge (typ. Q<sub>g</sub> = 43nC)
- 100% avalanche tested

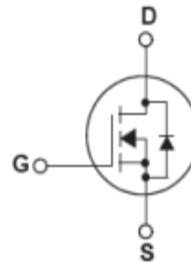

### Absolute Maximum Ratings

Symbol	Parameter	Value	Unit
V <sub>DSS</sub>	Drain-Source Voltage	600	V
I <sub>D</sub>	Drain Current -Continuous (TC = 25°C) -Continuous (TC = 100°C)	15 9.4	A
I <sub>DM</sub>	Drain Current – Pulsed (Note 1)	45	A
V <sub>GSS</sub>	Gate-Source voltage	±30	V
E <sub>AS</sub>	Single Pulsed Avalanche Energy (Note 2)	284	mJ
I <sub>AR</sub>	Avalanche Current (Note 1)	2.4	A
E <sub>AR</sub>	Repetitive Avalanche Energy (Note 1)	0.43	mJ
dv/dt	Peak Diode Recovery dv/dt (Note 3)	15	V/ns
P <sub>D</sub>	Power Dissipation (TC = 25°C)	104	W
T <sub>J</sub> , T <sub>STG</sub>	Operating and Storage Temperature Range	-55 to +150	°C
T <sub>L</sub>	Maximum Lead Temperature for Soldering Purpose, 1/8" from Case for 5 Seconds	300	°C

\* Drain current limited by maximum junction temperature.

### Thermal Characteristics

Symbol	Parameter	Value	Unit
R <sub>θJC</sub>	Thermal Resistance, Junction-to-Case	1.2	°C/W
R <sub>θCS</sub>	Thermal Resistance, Case-to-Sink Typ.	0.5	°C/W
R <sub>θJA</sub>	Thermal Resistance, Junction-to-Ambient	62	°C/W

## Electrical Characteristics TC = 25 °C unless otherwise noted

Symbol	Parameter	Conditions	Min	Typ	Max	Unit
Off Characteristics						
BV <sub>DSS</sub>	Drain-Source Breakdown Voltage	V <sub>GS</sub> = 0V, I <sub>D</sub> = 250μA, T <sub>J</sub> = 25 °C	600	--	--	V
		V <sub>GS</sub> = 0V, I <sub>D</sub> = 250μA, T <sub>J</sub> = 150 °C	--	650	--	V
ΔBV <sub>DSS</sub> / ΔT <sub>J</sub>	Breakdown Voltage Temperature Coefficient	I <sub>D</sub> = 250μA, Referenced to 25 °C	--	0.6	--	V/°C
I <sub>DSS</sub>	Zero Gate Voltage Drain Current	V <sub>DS</sub> = 600V, V <sub>GS</sub> = 0V -T <sub>C</sub> = 150 °C	--	-- 10	1 --	μA μA
I <sub>GSSF</sub>	Gate-Body Leakage Current, Forward	V <sub>GS</sub> = 30V, V <sub>DS</sub> = 0V	--	--	100	nA
I <sub>GSSR</sub>	Gate-Body Leakage Current, Reverse	V <sub>GS</sub> = -30V, V <sub>DS</sub> = 0V	--	--	-100	nA
On Characteristics						
V <sub>GS(th)</sub>	Gate Threshold Voltage	V <sub>DS</sub> = V <sub>GS</sub> , I <sub>D</sub> = 250μA	2.5	--	4.5	V
R <sub>DS(on)</sub>	Static Drain-Source On-Resistance	V <sub>GS</sub> = 10V, I <sub>D</sub> = 7.5A	--	0.24	0.28	Ω
g <sub>FS</sub>	Forward Trans conductance	V <sub>DS</sub> = 40V, I <sub>D</sub> = 15A (Note 4)	--	16	--	S
R <sub>g</sub>	Gate resistance	f=1 MHz, open drain	--	3.5	--	Ω
Dynamic Characteristics						
C <sub>iss</sub>	Input Capacitance	V <sub>DS</sub> = 25V, V <sub>GS</sub> = 0V, f = 1.0MHz	--	800	--	pF
C <sub>oss</sub>	Output Capacitance		--	340	--	pF
C <sub>rss</sub>	Reverse Transfer Capacitance		--	10	--	pF
Switching Characteristics						
t <sub>d(on)</sub>	Turn-On Delay Time	V <sub>DD</sub> = 400V, I <sub>D</sub> = 7.5A R <sub>G</sub> = 20Ω (Note 4, 5)	--	13	--	ns
t <sub>r</sub>	Turn-On Rise Time		--	11	--	ns
t <sub>d(off)</sub>	Turn-Off Delay Time		--	100	--	ns
t <sub>f</sub>	Turn-Off Fall Time		--	12	--	ns
Q <sub>g</sub>	Total Gate Charge	V <sub>DS</sub> = 480V, I <sub>D</sub> = 7.5A V <sub>GS</sub> = 10V (Note 4, 5)	--	43	--	nC
Q <sub>gs</sub>	Gate-Source Charge		--	5	--	nC
Q <sub>gd</sub>	Gate-Drain Charge		--	22	--	nC
Drain-Source Diode Characteristics and Maximum Ratings						
I <sub>S</sub>	Maximum Continuous Drain-Source Diode Forward Current		--	--	15	A
I <sub>SM</sub>	Maximum Pulsed Drain-Source Diode Forward Current		--	--	45	A
V <sub>SD</sub>	Drain-Source Diode Forward Voltage	V <sub>GS</sub> = 0V, I <sub>F</sub> = 7.5A	--	0.9	1.5	V
t <sub>rr</sub>	Reverse Recovery Time	V <sub>GS</sub> = 0V, I <sub>F</sub> = 7.5A di <sub>F</sub> /dt = 100A/μs (Note 4)	--	345	--	ns
Q <sub>rr</sub>	Reverse Recovery Charge		--	4.5	--	μC

## NOTES:

1. Repetitive Rating: Pulse width limited by maximum junction temperature
2. I<sub>AS</sub>=2.4A, V<sub>DD</sub>=50V, Starting T<sub>J</sub>=25 °C
3. I<sub>SD</sub>≤15A, di/dt ≤ 200A/μs, V<sub>DD</sub> ≤ BV<sub>DSS</sub>, Starting T<sub>J</sub> = 25 °C
4. Pulse Test: Pulse width ≤ 300μs, Duty Cycle ≤ 2%
5. Essentially Independent of Operating Temperature Typical Characteristics

# Typical Performance Characteristics

Power dissipation

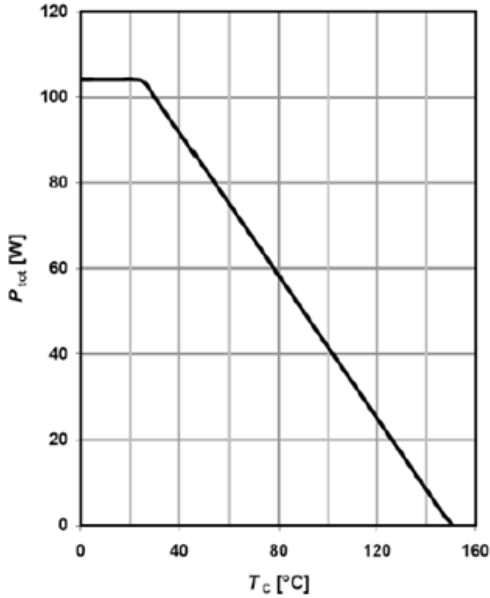

$$P_{tot} = f(T_C)$$

Max. transient thermal impedance

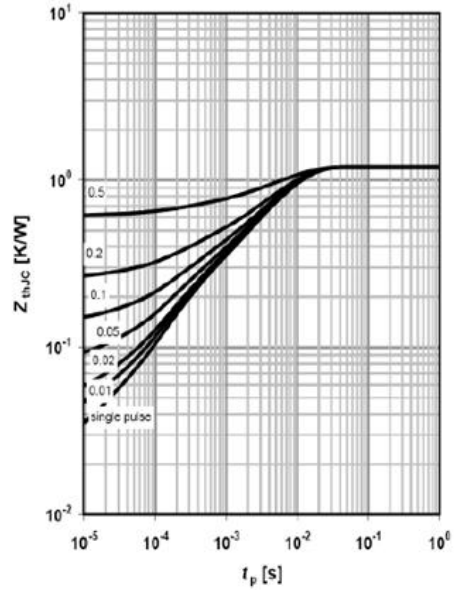

$$P_{tot} = f(T_C)$$

Safe operating area  $T_C = 25\text{ }^\circ\text{C}$

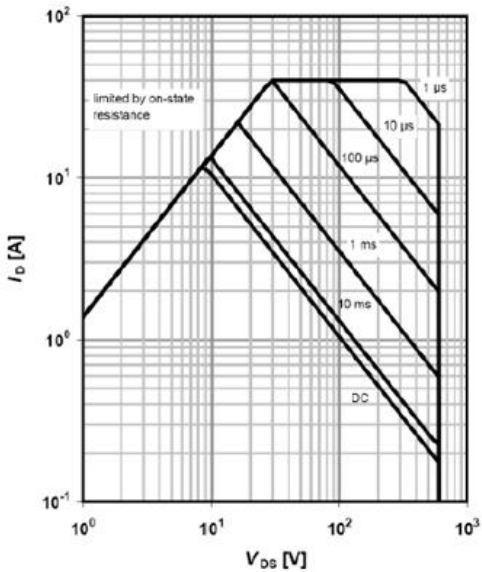

$$I_D = f(V_{DS}); T_C = 25\text{ }^\circ\text{C}; V_{GS} > 7\text{V}; D = 0; \text{parameter } t_p$$

Safe operating area  $T_C = 80\text{ }^\circ\text{C}$

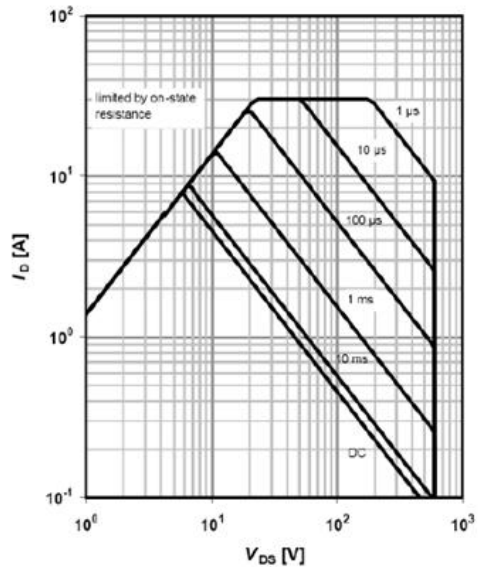

$$I_D = f(V_{DS}); T_C = 80\text{ }^\circ\text{C}; V_{GS} > 7\text{V}; D = 0; \text{parameter } t_p$$

# Typical Performance Characteristics

Typ. output characteristics  $T_j=25^\circ\text{C}$

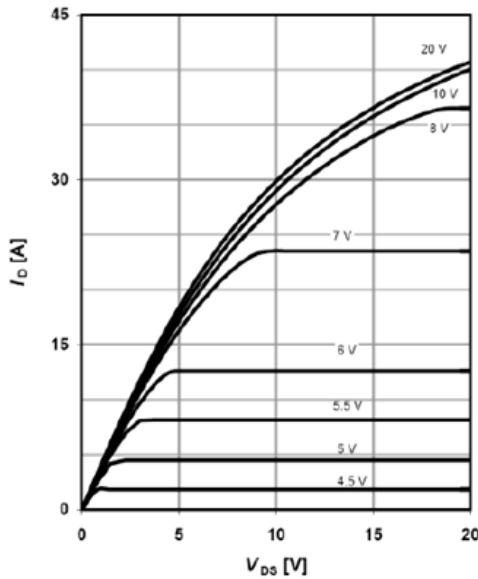

$I_D=f(V_{DS}); T_j=25^\circ\text{C}$  ; parameter:  $V_{GS}$

Typ. output characteristics  $T_j=125^\circ\text{C}$

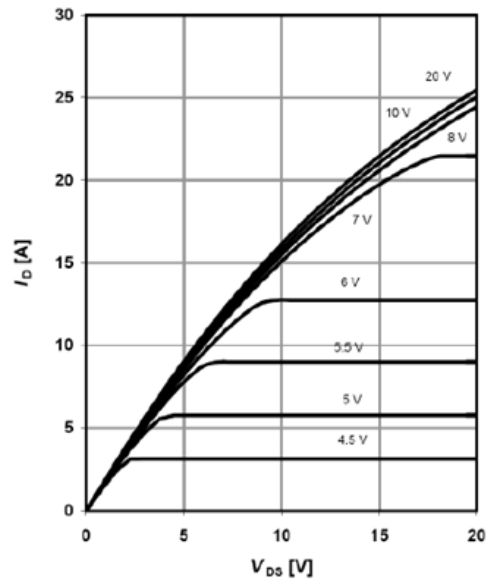

$I_D=f(V_{DS}); T_j=125^\circ\text{C}$  ; parameter:  $V_{GS}$

Typ. drain-source on-state resistance

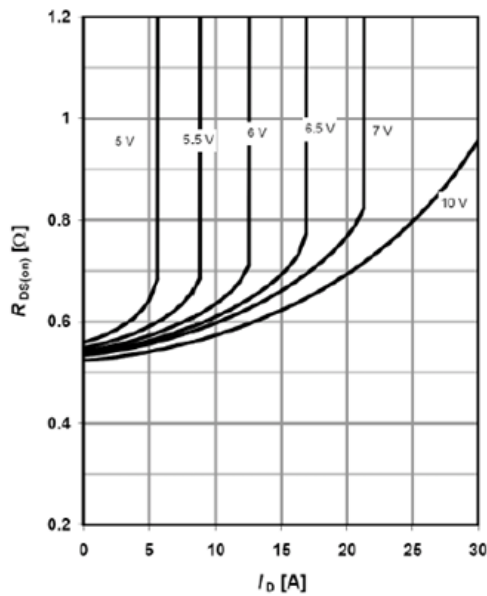

$R_{DS(on)}=f(I_D); T_j=125^\circ\text{C}$  ;  
parameter:  $V_{GS}$

Typ. drain-source on-state resistance

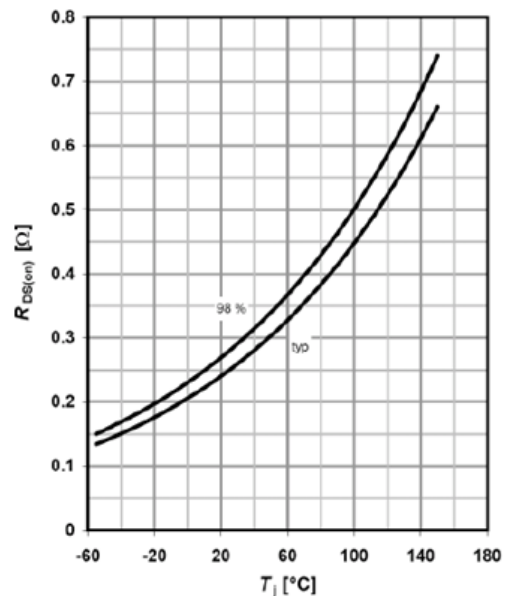

$R_{DS(on)}=f(T_j); I_D=6.5\text{ A}; V_{GS}=10\text{ V}$

# Typical Performance Characteristics

Typ. transfer characteristics

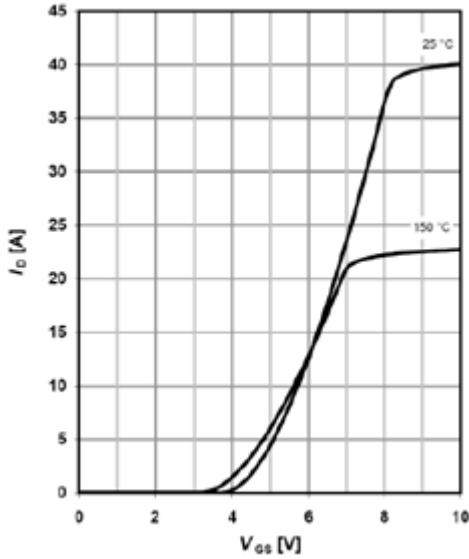

$$I_D = f(V_{GS}); V_{DS} = 20V$$

Typ. gate charge

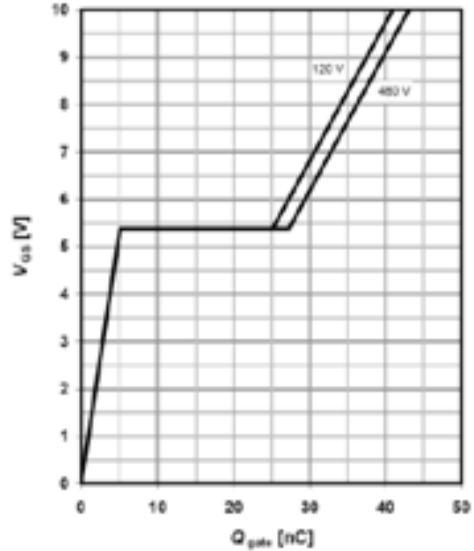

$$V_{GS} = f(Q_g), I_D = 6.5A \text{ pulsed}$$

Avalanche energy

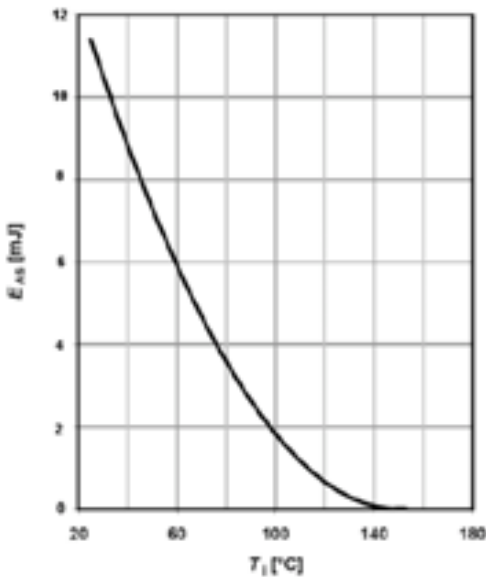

$$E_{AS} = f(T_j); I_D = 6.5A; V_{DD} = 50V$$

Drain-source breakdown voltage

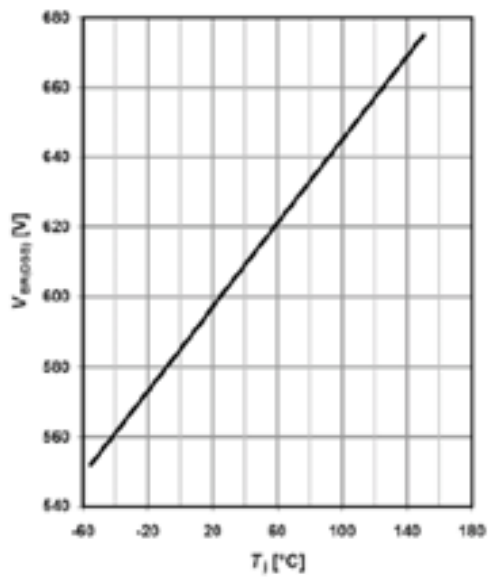

$$V_{BR(DSS)} = f(T_j); I_D = 0.25mA$$

# Typical Performance Characteristics

Typ. capacitances

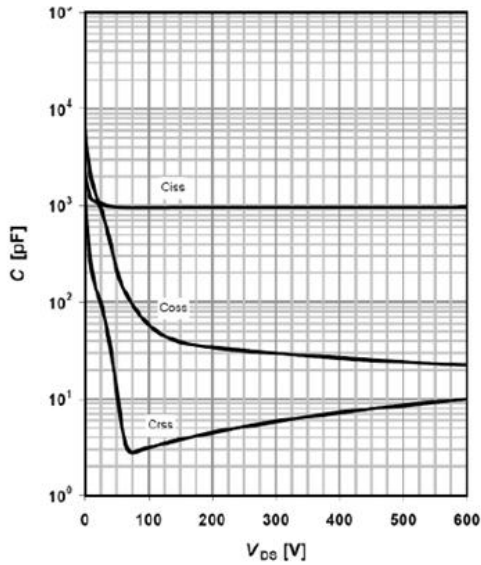

$$C=f(V_{DS}); V_{GS}=0\text{ V}; f=1\text{ MHz}$$

Typ. *Coss* stored energy

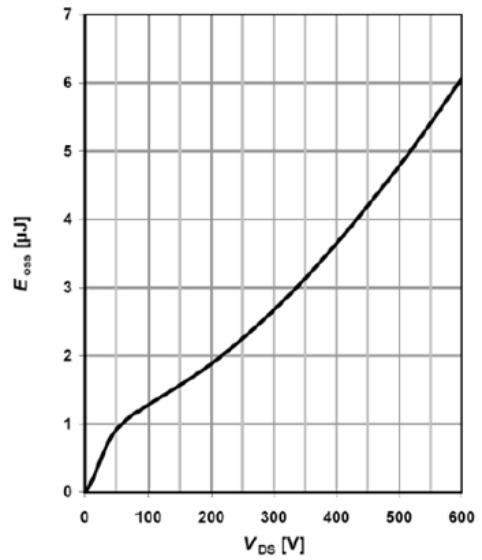

$$E_{OSS}=f(V_{DS})$$

Forward characteristics of reverse diode

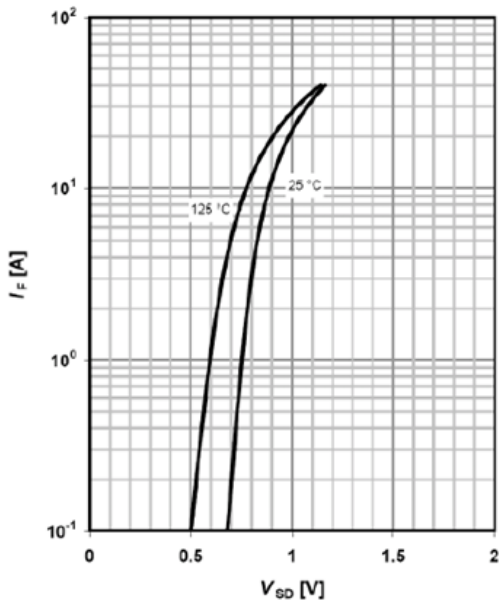

$$I_F=f(V_{SD}); \text{parameter: } T_j$$

# Test circuits

## Switching times test circuit and waveform for inductive load

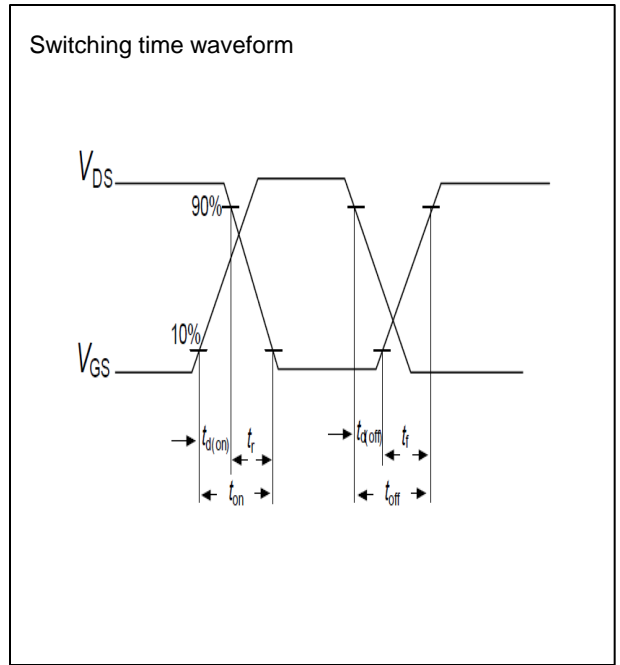
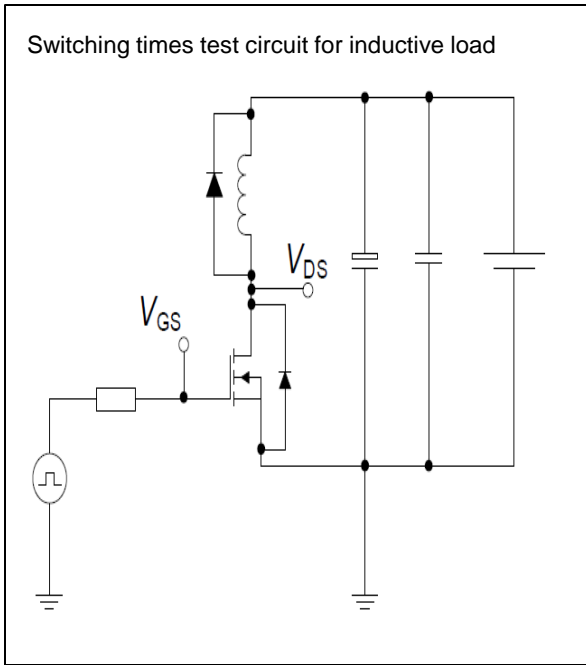

## Unclamped inductive load test circuit and waveform

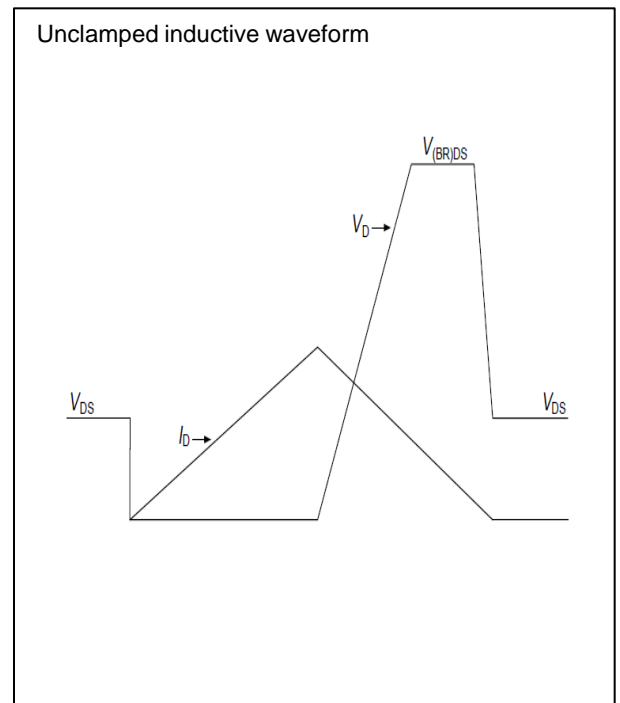
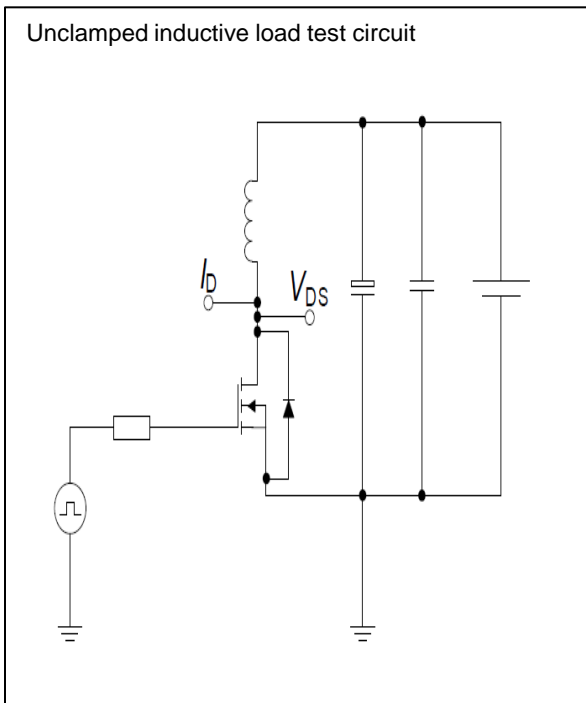

# Test circuits

## Test circuit and waveform for diode characteristics

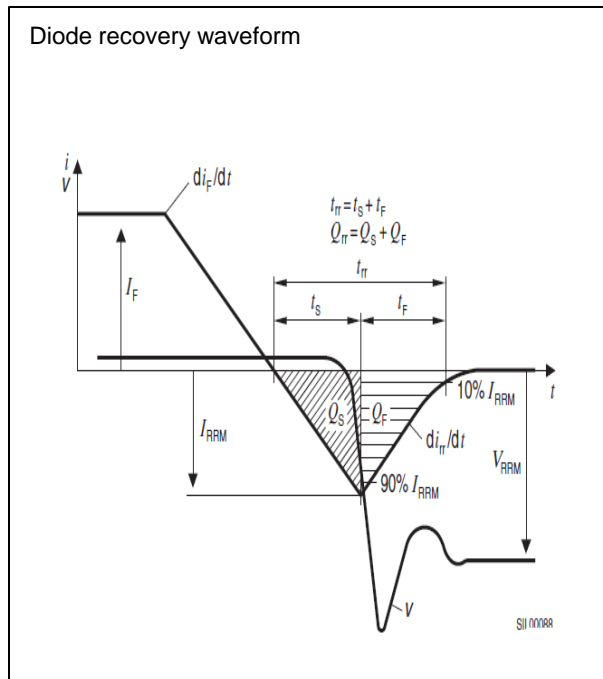
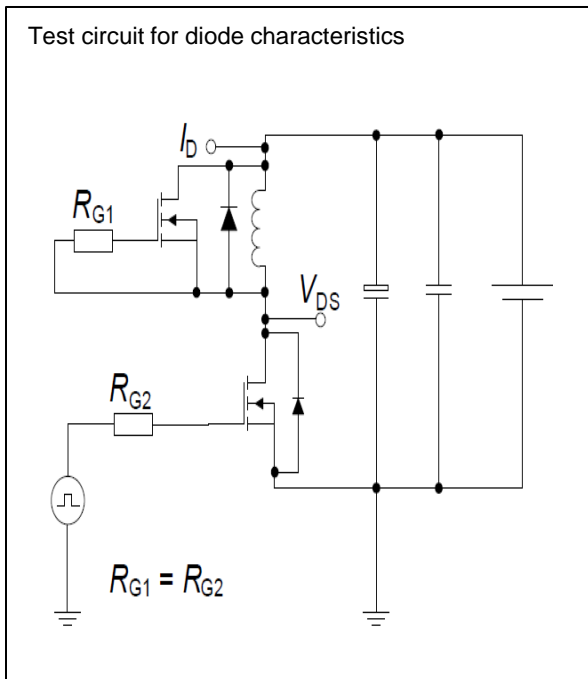



# Package Outline TO-220

TSP60R280S1 600V 15A N-Channel SJ-MOSFET

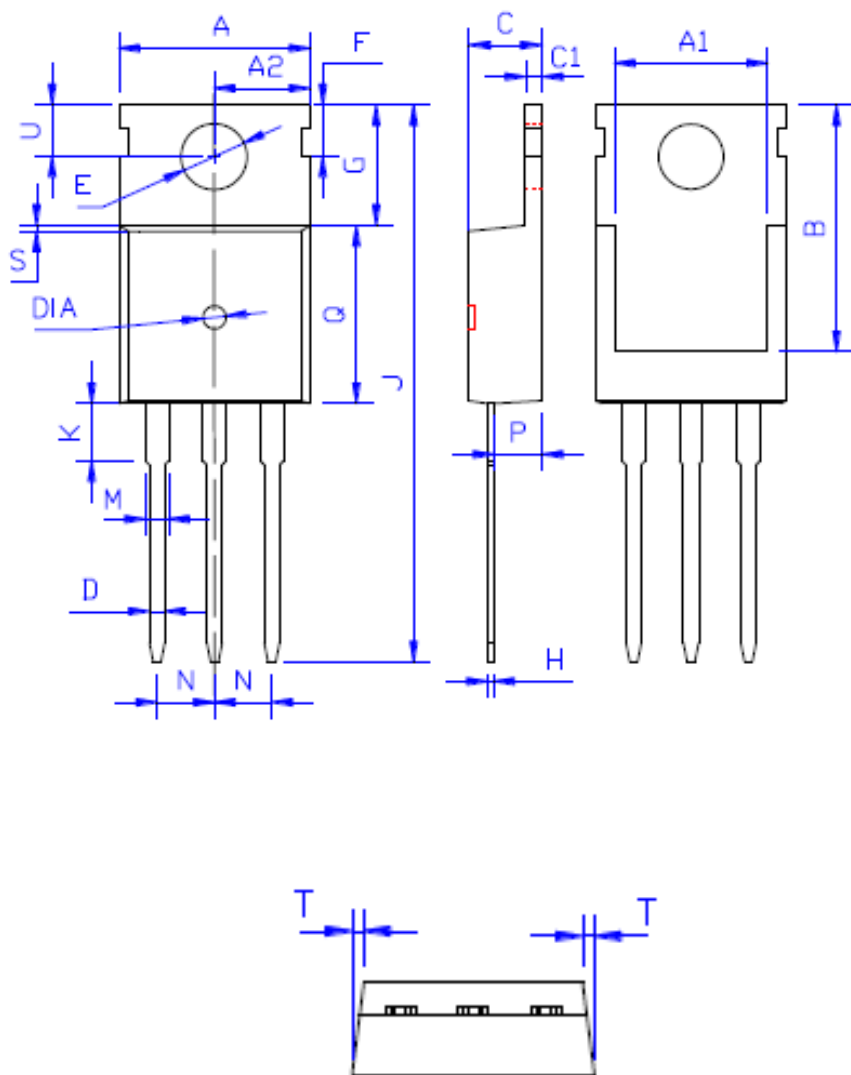

DIM	MILLIMETERS
A	10.00 ± 0.30
A1	8.00 ± 0.30
A2	5.00 ± 0.30
B	13.20 ± 0.40
C	4.50 ± 0.20
C1	1.30 ± 0.20
D	0.80 ± 0.20
E	3.60 ± 0.20
F	3.00 ± 0.30
G	6.60 ± 0.40
H	0.50 ± 0.20
J	28.88 ± 0.50
K	3.00 ± 0.30
M	1.30 ± 0.30
N	Typical 2.54
P	2.40 ± 0.40
Q	9.20 ± 0.40
S	0.25 ± 0.15
T	0.25 ± 0.15
U	2.80 ± 0.30
DIA	宽 1.50 ± 0.10 深 0.50 <b>MAX</b>